

## ICE-Trade Steel Conveyor Covers

### Profiles

#### Standard profile 27/100/0,80

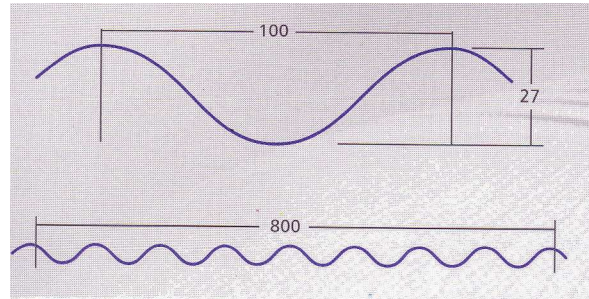

#### Export profile 18/76/0,75

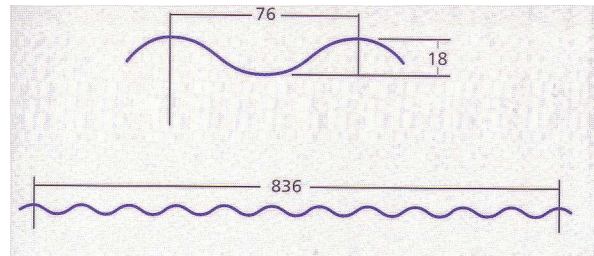

#### Jumbo profile 27/111

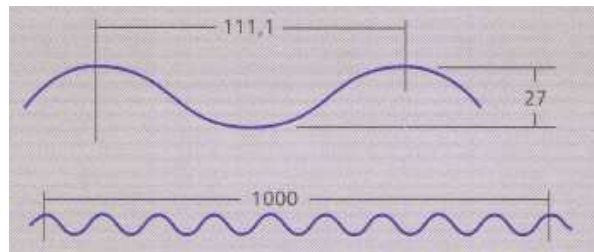

#### Special profile 42/160

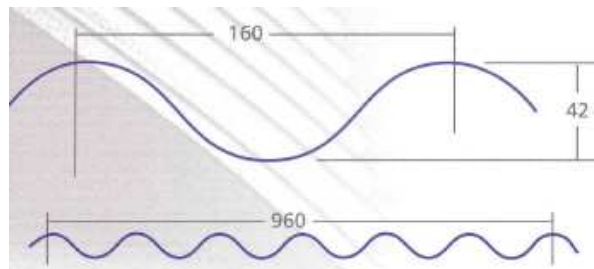



**ICE-Trade sa**  
International Conveyor Equipment & Trading

Tel. + 32.56.48 18 80  
Fax + 32.56.48 18 88  
[info@ice-trade.com](mailto:info@ice-trade.com)  
[www.ice-trade.com](http://www.ice-trade.com)

### Standard Covers dimensions

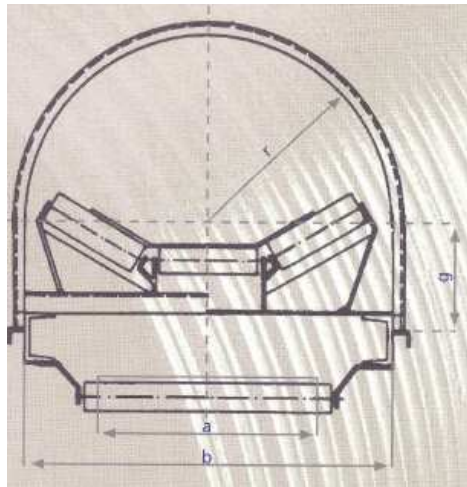

Cover N°	Belt width a	Installation width b	Radius r	Weight approx. kg.	Straight part g
0	300	600	300	8,9	Standard
1	400	700	350	9,9	200 mm.
2	500	800	400	10,9	Min. 150 mm.
3	650	950	475	12,4	
4	800	1150	575	14,4	Max. on request.
5	1000	1350	675	16,4	
6	1200	1600	800	18,9	Also available without
7	1400	1800	900	20,9	
8	1600	2050	1025	22,9	
9	1800	2250	1125	25,0	
10	2000	2500	1250	27,5	
All sizes in mm. Other dimensions on request available.					

Standard covers are produced with the profile 27 / 100 / 0,80 mm., useful length 800 mm.

The export profile 18 / 76 / 0,75 mm. has an useful length of 836 or 1064 mm.

Jumbo profile, exclusive profile 27 / 111 with a useful length of 1000 mm. which makes the axle distance = the number of covers.

The special profile 42 / 160 is conceived for the big Jumbo Covers, till 4,5 m. radius, rolled, useful length 960 mm.



## ICE-Trade sa

International Conveyor Equipment & Trading

Tel. + 32.56.48 18 80

Fax + 32.56.48 18 88

[info@ice-trade.com](mailto:info@ice-trade.com)

[www.ice-trade.com](http://www.ice-trade.com)

### Standard Cover



#### Materials:

- Quality steel, hot galvanized
- Aluminum
- Stainless steel
- Hard PVC. See page .

#### Finish:

- Hot galvanized, both sides
- Aluzink
- Powder coated in all RAL colors

#### Advantages:

- No under construction needed
- Inflammable
- Unbreakable
- No maintenance needed, for years
- Very solid
- Easy to recycle
- Environment friendly
- Cost effective



**ICE-Trade sa**  
International Conveyor Equipment & Trading

Tel. + 32.56.48 18 80  
Fax + 32.56.48 18 88  
[info@ice-trade.com](mailto:info@ice-trade.com)  
[www.ice-trade.com](http://www.ice-trade.com)

## Special Covers

### Top Cover

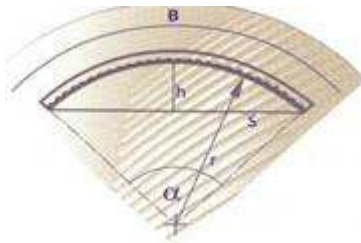
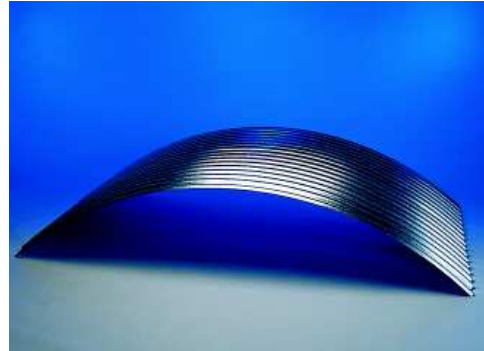

The sizes width, height and the length are necessary for us, to be able to make a quotation.  
Top Covers are fixed with L-bolts.

### NEW ! The Bow Cover

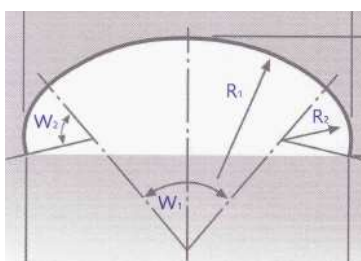
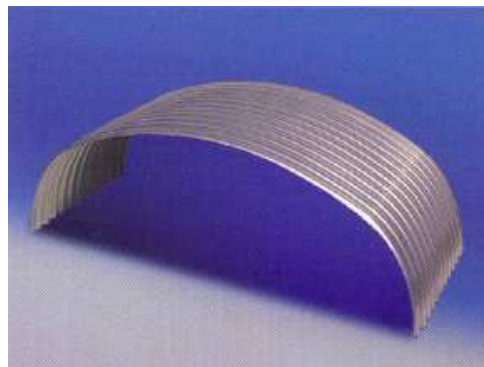

The low height makes this cover ideal for conveyors with structures above the installation.  
The sizes width, height,  $R_1 + 2 / W_1 + 2$  and the length are necessary for us, to be able to make a quotation.



**ICE-Trade sa**  
International Conveyor Equipment & Trading

Tel. + 32.56.48 18 80  
Fax + 32.56.48 18 88  
[info@ice-trade.com](mailto:info@ice-trade.com)  
[www.ice-trade.com](http://www.ice-trade.com)

### Segment Cover

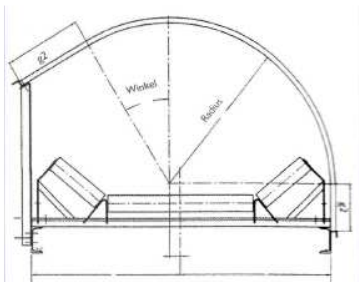

For this cover the sizes G1+2, the angle & radius are needed for production.

### JUMBO COVER

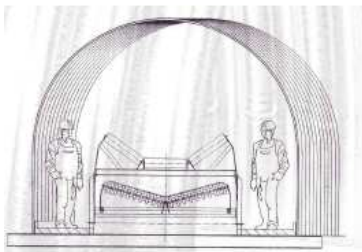
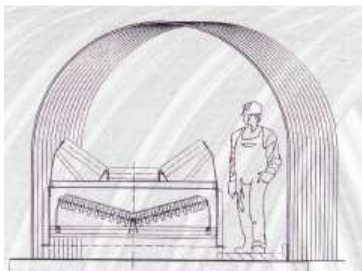

On request, static calculation can be made. The max. radius is 4,5 m. rolled.



**ICE-Trade sa**  
International Conveyor Equipment & Trading

Tel. + 32.56.48 18 80  
Fax + 32.56.48 18 88  
[info@ice-trade.com](mailto:info@ice-trade.com)  
[www.ice-trade.com](http://www.ice-trade.com)

## Inspection Covers

### Sliding Covers (European Patent)



### Hinged inspection Covers



### Removable Cover





**ICE-Trade sa**  
International Conveyor Equipment & Trading

Tel. + 32.56.48 18 80  
Fax + 32.56.48 18 88  
[info@ice-trade.com](mailto:info@ice-trade.com)  
[www.ice-trade.com](http://www.ice-trade.com)

### Door Inspection Cover

**Open**



**Closed**



**Open Cover**



### Hinged inspection Cover 2





**ICE-Trade sa**  
International Conveyor Equipment & Trading

Tel. + 32.56.48 18 80  
Fax + 32.56.48 18 88  
[info@ice-trade.com](mailto:info@ice-trade.com)  
[www.ice-trade.com](http://www.ice-trade.com)

## NEW ! LOOP-Cover



For regular inspection: at both sides of the inspection-cover solid handles are fixed. The cover is fixed with short tensioners, easy to be removed.

We advice to install all the covers :  
up - down - up - etc. to easily remove the covers for any need.     - \_ - \_ - \_ -

## Ventilation Cover



## Cover Fixing Systems

### Strap type K

Hook →

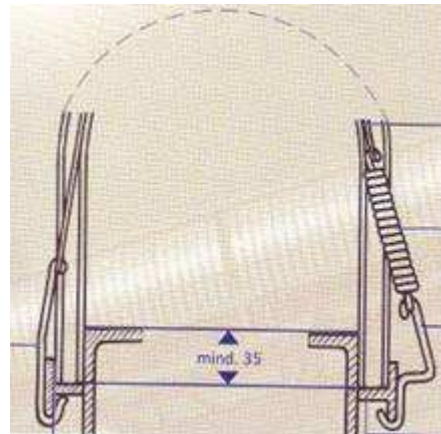

← Stainless steel strap  
← Spring

← Hook handle  
← Hole  $\varnothing$  9 mm. as high as possible

← T-profile, 30 mm. width

### Strap type SK

M6 x 20 with →  
bolt & washer

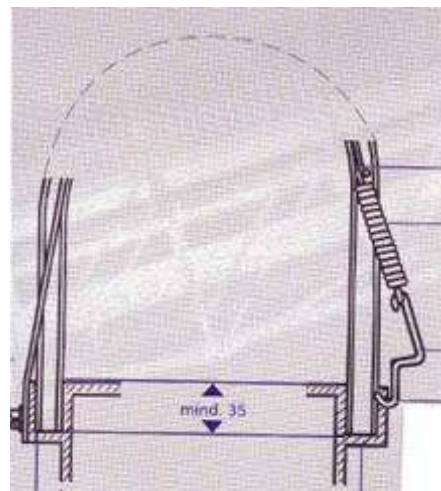

← Stainless steel strap  
← Spring

← Hook handle

← Hole  $\varnothing$  9 mm.  
← L-profile, 30 mm.

### Strap type S

M 6 x 20 with bolt  
& washer →

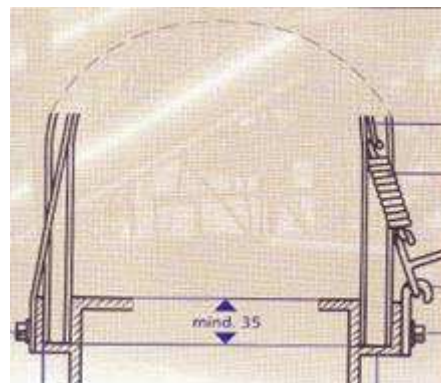

← Stainless steel strap  
← Spring

← Tensioner  
← Hook  
← M8 x 20 with bolt & washer

← Support L-profile, 30 mm.

**NEW ! KS Spring (pat. pending)**

With the KS strap, including the KS spring, in stainless steel, the covers until cover n° 10 can be fixed with only 1 strap per standard cover.

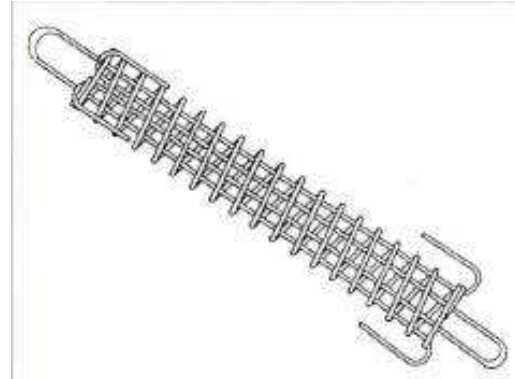

**Fastener Type H**

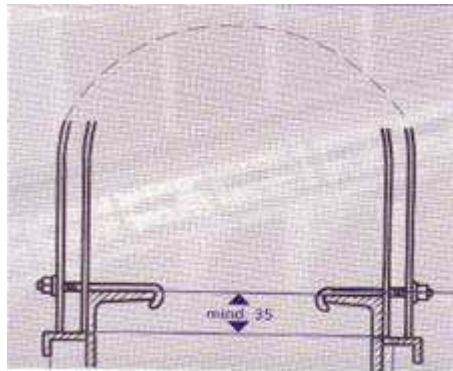

- ← Hook-bolt M8 with bolt & washer
- ← L-profile

**Fastener Type L**

M8 storm bolt with bolt & washer →  
U-profile from installation →  
For the Top Cover

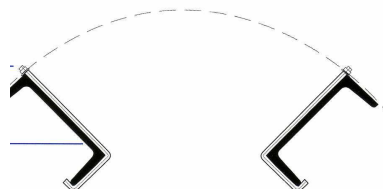



**ICE-Trade sa**  
International Conveyor Equipment & Trading

Tel. + 32.56.48 18 80  
Fax + 32.56.48 18 88  
[info@ice-trade.com](mailto:info@ice-trade.com)  
[www.ice-trade.com](http://www.ice-trade.com)

## Specials

### Under-Covers

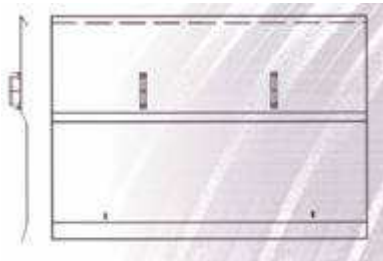

The Under-Covers are available in :  
- bent steel sheet  
- rolled trapeze sheet

They come with :  
- handles for easy handling  
- holes for easy installation

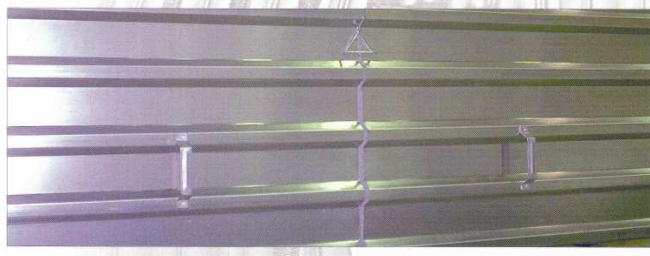

### NEW ! Acoustic Covers

Single cover with noise reducing material inside

Double cover with  
- inside perforated cover  
- noise reducing material in between  
- standard cover at the outside



## ICE-Trade Hard PVC Covers

### Greca Profile 70/18

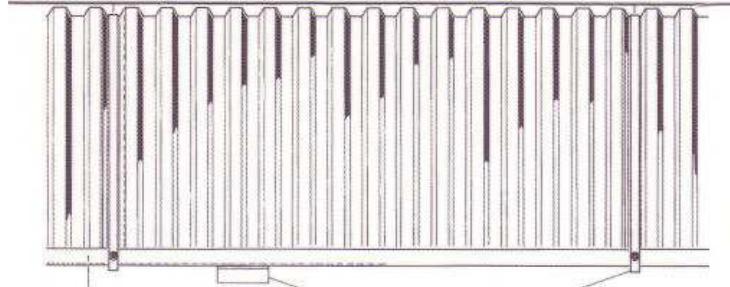

This cover is supported by a T-profile, 20 mm. wide, over the whole length.

### Cover dimensions

Cover n°	Belt width	Installation width	Radius	Weight / cover	Needed fasteners / cover	Weight per fastener / cover
1	400	700	350	3,6	1 strap	0,5
2	500	800	400	4,0	1 strap	0,5
3	650	950	475	4,5	1 strap	0,5
4	800	1150	575	5,3	2 straps	1,0
5	1000	1350	675	6,0	2 bows	7,4
6	1200	1600	800	7,0	2 bows	7,6
7	1400	1800	900	7,7	2 bows	7,7

Straight is 200 mm. All dimensions in mm. and kg.

### Fixing the hard PVC Covers

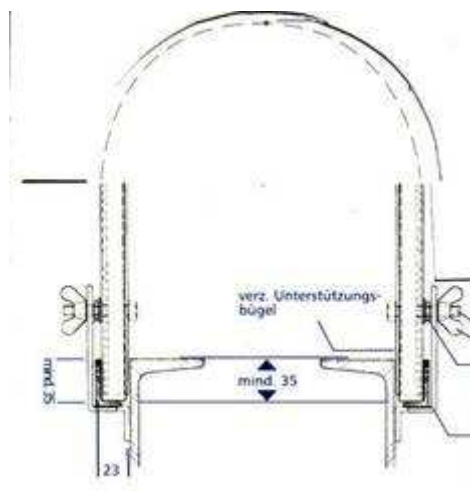

← Bow 20x20x2 mm. galvanized

← Bolt M6 x 45 with wing nut

← Nut & washer

← Flat steel holder

### Characteristics **Hard PVC Covers**

- Uninflammable according DIN 4102
- Burst resistant acc. DIN 7748
- Chemical resistant acc. DIN 16929
- Maintenance free
- Low weight
- Easy to install

### Fixing of the **Hard PVC Covers**

- Cover 1 till 4 can be fixed with stainless steel straps; N° 4 with 2 pieces
- Covers 5 till 7 are fixed with a bow, steel profile 20 x 20 x 2 mm., which are hot galvanized.
- All hard PVC covers must be supported by a steel profile, 20 mm. wide, over the whole length of the installation.

### Applications



← Standard Covers from seawater resistant aluminum



LOOP-Covers →



← Truck leaves the plant with 300 JUMBO COVERS

For further information, please do not hesitate to contact us.